

**66015**      **3N243**  
**3N244**      **TO-18 OPTOCOUPLERS**  
**3N245**



05/29/03

**Features:**

- High Reliability
- Base lead eliminated for improved noise immunity
- Rugged package
- Stability over wide temperature
- 1kV electrical isolation

**Applications:**

- Eliminate ground loops
- Level shifting
- Line receiver
- Switching power supplies
- Motor control

**DESCRIPTION**

The **66015** contains an infrared LED optically coupled to a silicon phototransistor in a hermetic 4 lead TO-18 package. The collector of the phototransistor is electrically connected to the case. The internal base connection has been eliminated for improved noise immunity. The 3N243, 3N244 and 3N245 can be supplied to commercial or screened quality levels as well as to customer specifications.

**ABSOLUTE MAXIMUM RATINGS**

Input to Output Voltage .....	1000V
Emitter-Collector Voltage .....	7V
Collector-Emitter Voltage .....	35V
Reverse Input Voltage .....	2V
Input Diode Continuous Forward Current at (or below) 65°C Free-Air Temperature (see note 1) .....	40mA
Continuous Collector Current .....	50mA
Continuous Transistor Power Dissipation at (or below) 25°C Free-Air Temperature (see Note 2) .....	190mW
Storage Temperature .....	-55°C to +150°C
Operating Free-Air Temperature Range.....	-55°C to +125°C
Lead Solder Temperature (10 seconds max, 1/16" from case) .....	240°C

**Notes:**

1. Derate linearly to 125°C free-air temperature at the rate of 0.67 mA/°C.
2. Derate linearly to 125°C free-air temperature at the rate of 1.9 mW/°C.

**Package Dimensions**

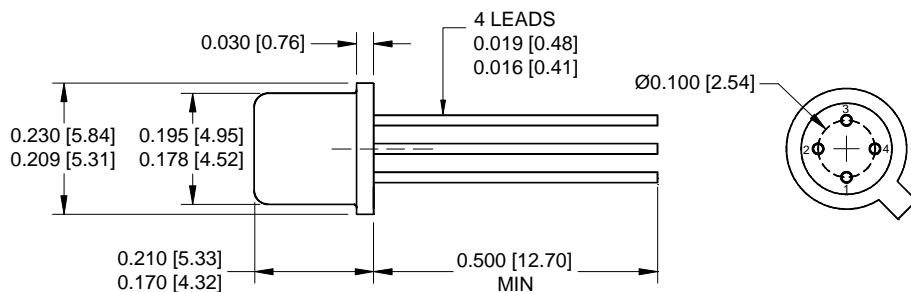

ALL DIMENSIONS ARE IN INCHES [MILLIMETERS]

**Schematic Diagram**

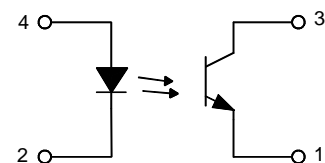

THE COLLECTOR IS IN ELECTRICAL CONTACT WITH THE CASE.

**66015**    **3N243**  
               **3N244**  
               **3N245**

TO-18 OPTOCOUPLER

05/29/03

**ELECTRICAL CHARACTERISTICS**

**INPUT LED**

T<sub>A</sub> = 25°C

PARAMETER		MIN	TYP	MAX	UNITS	TEST CONDITIONS
Input Diode Static Forward Voltage	V <sub>F</sub>	0.8		1.3	V	I <sub>F</sub> = 10mA
Input Diode Reverse Current	I <sub>R</sub>			100	μA	V <sub>R</sub> = 2 V

**OUTPUT TRANSISTOR**

T<sub>A</sub> = 25°C

PARAMETER	SYMBOL	MIN	TYP	MAX	UNITS	TEST CONDITIONS
Collector-Emitter Breakdown Voltage	V <sub>(BR)CEO</sub>	35			V	I <sub>C</sub> = 1mA, I <sub>F</sub> = 0
Emitter-Collector Breakdown Voltage	V <sub>(BR)ECO</sub>	7			V	I <sub>E</sub> = 100μA, I <sub>F</sub> = 0
Collector-Emitter Dark Current	I <sub>D</sub>			100	nA	V <sub>CE</sub> = 10V, I <sub>F</sub> = 0mA

**COUPLED CHARACTERISTICS**

T<sub>A</sub> = 25°C unless otherwise specified.

PARAMETER		SYMBOL	MIN	TYP	MAX	UNITS	TEST CONDITIONS
On State Collector Current	3N243 3N244 3N245	I <sub>C(ON)</sub>	1.5 3.0 6.0			mA	V <sub>CE</sub> = 10V, I <sub>F</sub> = 10mA
Collector-Emitter Saturation Voltage	3N243 3N244 3N245	V <sub>CE(SAT)</sub>			0.3 0.3 0.3	V V V	I <sub>F</sub> = 20mA, I <sub>C</sub> = 1.5mA I <sub>F</sub> = 20mA, I <sub>C</sub> = 3mA I <sub>F</sub> = 20mA, I <sub>C</sub> = 6mA
DC Isolation Voltage		V <sub>IO</sub>	1000			V	I <sub>IO</sub> = 100nA
Rise Time	3N243 3N244 3N245	t <sub>r</sub>		3 3 6	20 20 20	μs	V <sub>CE</sub> = 10V, I <sub>F</sub> = 10mA, R <sub>L</sub> = 100Ω
Fall Time	3N243 3N244 3N245	t <sub>f</sub>		3 3 6	20 20 20	μs	V <sub>CE</sub> = 10V, I <sub>F</sub> = 10mA, R <sub>L</sub> = 100Ω

**RECOMMENDED OPERATING CONDITIONS:**

PARAMETER	SYMBOL	MIN	MAX	UNITS
Input Current, Low Level	I <sub>FL</sub>	0	10	μA
Input Current, High Level	I <sub>FH</sub>	1	20	mA
Supply Voltage	V <sub>CE</sub>	5	10	V

**SELECTION GUIDE**

PART NUMBER	PART DESCRIPTION
66015-001	3N243, Commercial
66015-002	3N244, Commercial
66015-003	3N245, Commercial
66015-101	3N243, Screened
66015-102	3N244, Screened
66015-103	3N245, Screened

05/29/03

PARAMETER MEASUREMENT INFORMATION

ADJUST AMPLITUDE OF INPUT PULSE FOR  
 $I_{C(ON)} = 5 \text{ mA}$

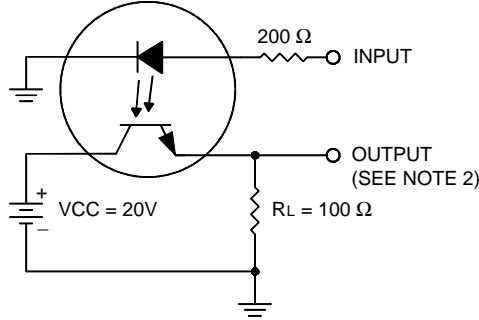

TEST CIRCUIT

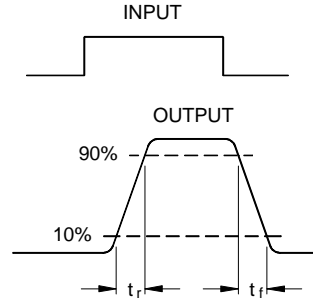

VOLTAGE WAVEFORM

- NOTES: 1. The input waveform is supplied by a generator with the following characteristics:  $Z_{OUT} = 50 \Omega$ ,  $t_r \leq 15 \text{ ns}$ , Duty cycle  $\approx 1\%$ ,  $t_w = 100 \mu\text{s}$ .  
2. Waveforms are monitored on an oscilloscope with the following characteristics:  $t_r \leq 12 \text{ ns}$ ,  $R_{IN} \geq 1 \text{ M}\Omega$ ,  $C_{IN} \leq 20 \text{ pF}$ .

TYPICAL CHARACTERISTICS

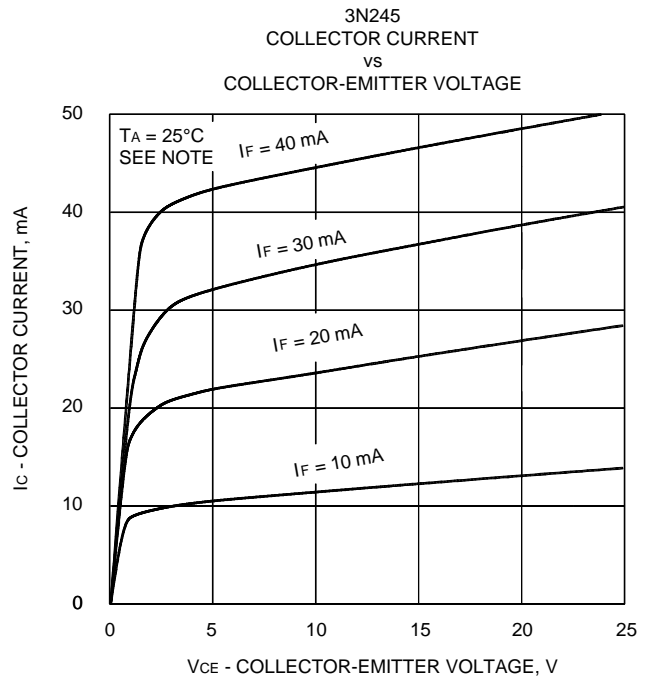
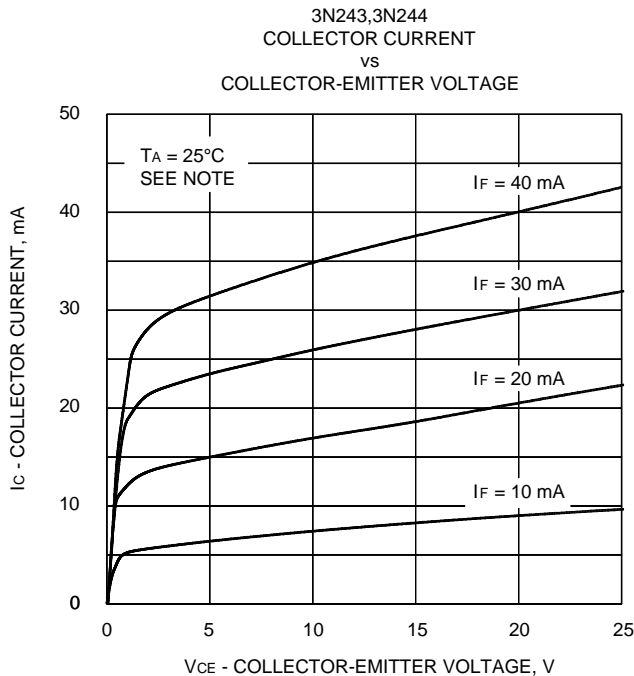

NOTE: This parameter was measured using pulse techniques.  $T_w = 100 \mu\text{s}$ , duty cycle = 1%.

05/29/03

TYPICAL CHARACTERISTICS (CONTINUED)

INPUT DIODE FORWARD CONDUCTION CHARACTERISTICS

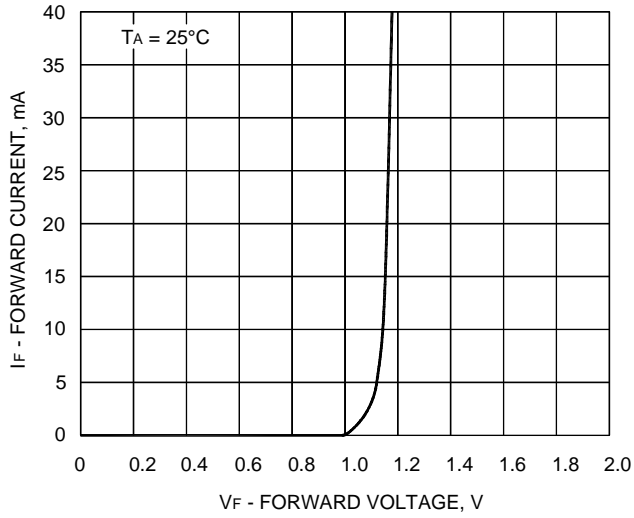

NORMALIZED ON STATE COLLECTOR CURRENT  
 VS  
 FREE-AIR TEMPERATURE

